

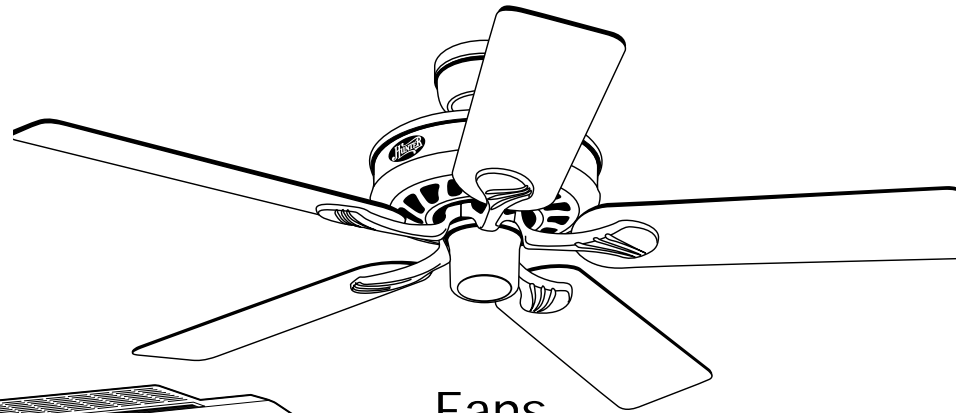

## Other Quality Products from Hunter

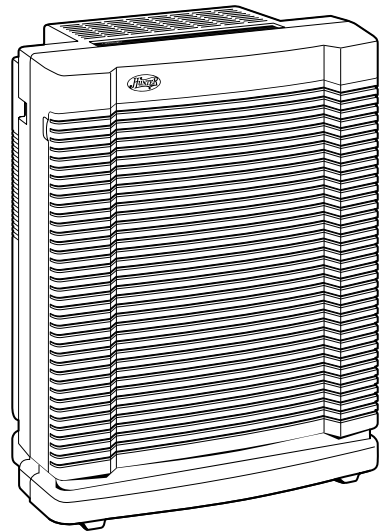

Fans



Air Purifiers

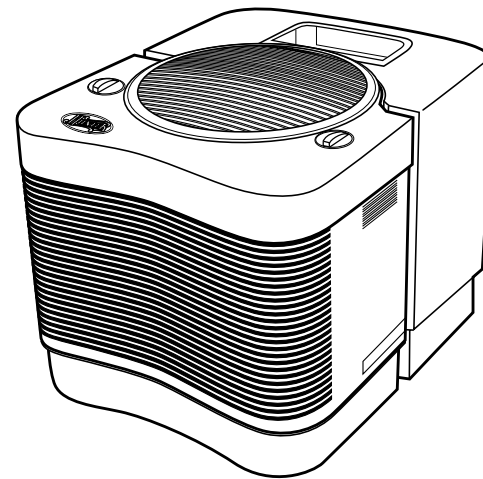

Humidifiers

We are pleased you have selected one of our broad line of home comfort products. Our products are manufactured to high quality standards and are designed for years of service. We hope you will be satisfied and thank you for buying a Hunter product.

## **Table Of Contents**

<b>Installation</b>	Features	6
	Remove Old Thermostat	8
	Labeling Wires	10
	System Selector Switches	14
	Connecting Wires and Mounting Thermostat	14
<b>Operation</b>	Programming/Setting Clock	16
	Personal Program Schedule	20
	Reviewing Program Settings	26
	Manual Override	27
	Temperature Span	30
	Backlighting	30
	Filter Monitor	31
	Trouble Shooting Guide	32
	Typical Wiring Diagrams	34

## Read This Before Installing Thermostat

---

### IMPORTANT

**1** Read the entire installation section of this Owner's Manual thoroughly before you begin to install or operate your Hunter Thermostat.

- Remove the mylar label from the display window.

### INSTALLATION

**2** All installation is normally performed at your thermostat.

### PROGRAMMING

**3** You can practice programming before installing your thermostat by inserting and connecting the batteries and following the instructions on page 14. This can be done while you relax in your favorite chair and is a very good way to familiarize yourself with all the functions of your Hunter Thermostat.

### OPERATION

**4** Your Hunter Thermostat is designed to operate with most gas, oil, electric or 2-wire hot water heating, and air conditioning systems that have 24-volt or millivolt control.

This Hunter Thermostat will not control multi-stage heating or cooling systems, 110/220 V systems, or 3 wire zone systems.

### COMPRESSOR PROTECTION

**5** The thermostat provides a 4-minute delay after shutting off the compressor before it can be restarted. This feature will prevent damage to your air conditioner compressor caused by rapid cycling. It does not provide a delay when there are power outages.

### TEMPERATURE RANGE

**6** Your thermostat can be programmed between 40°F and 95°F (5°C and 35°C). However, it will display room temperatures from 32°F to 99°F (0°C and 37°C).

### POWER FAILURE

**7** Whenever the main power is interrupted or fails, the battery power retains the programs and current time.

### **BATTERY WARNING**

**8** When the batteries are low, the "LOW BATT" indicator on the display will flash. When this happens, install new batteries immediately. Once the "LOW BATT" indicator appears, the thermostat will continue to operate for approximately 30 days. (Only alkaline batteries should be used in your thermostat. Rechargeable batteries have different properties which may cause the thermostat to not operate properly. Do not use old batteries.) The batteries should last one year.

**CAUTION:** *The batteries are the only source of power used to operate your system. If you do not replace the batteries, the display will dim and your heating and cooling system will stop operation.*

**NOTE:** *If you plan to be away from the premises over 30 days, we recommend that you replace the old batteries with new alkaline batteries prior to leaving.*

## **How This Thermostat Works...And Saves You Money**

This thermostat is designed to optimize the use of your heating and cooling equipment. It does this by matching your comfort (the temperatures in your home) to your schedule.

An example:

- 6:00 am – You wake up. Program 1 has the heat set to 70° (21°C).
- 7:30 am – You leave for work. The second program turns the heat back to 62° (17°C) while you are away.
- 5:00 pm – You come home. The third program has already warmed your house back to 70° (21°C).
- 10:00 pm – You go to bed. A half hour later, program 4 turns the heat back to 64° (18°C) to save energy while you are under the blankets.

# Features



Display shows time, day, temperature, program number, hold, usage and low battery indicator.

Individual pushbuttons for raising or lowering temperature settings.

Display backlight for viewing in the dark. (Feature found only on certain models.)

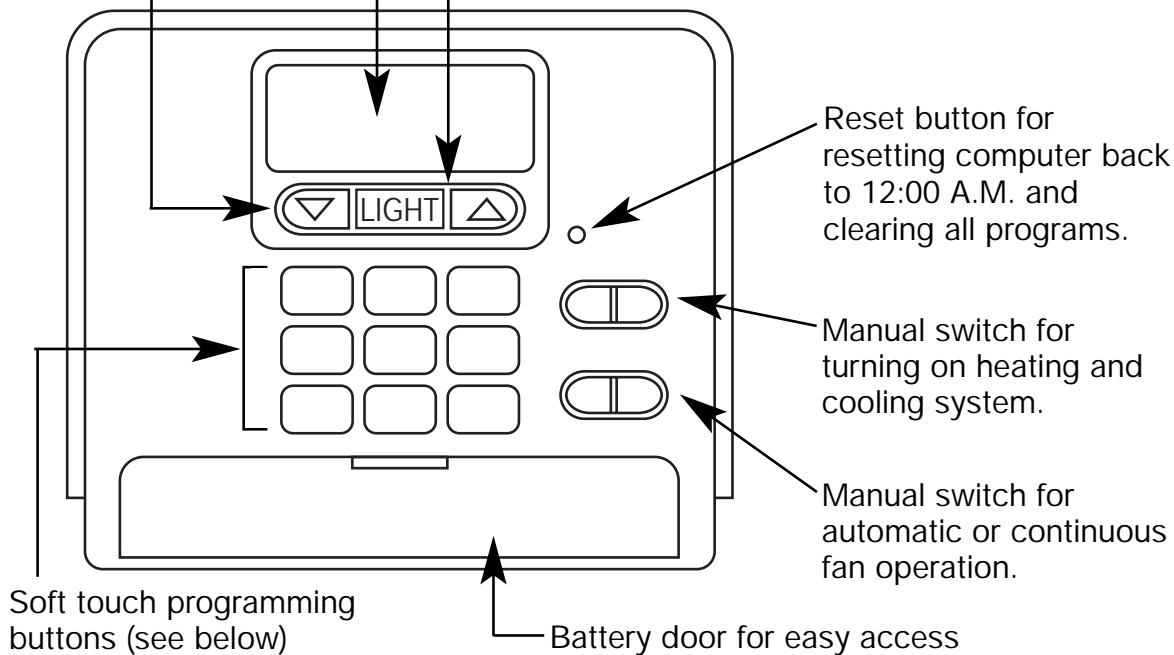

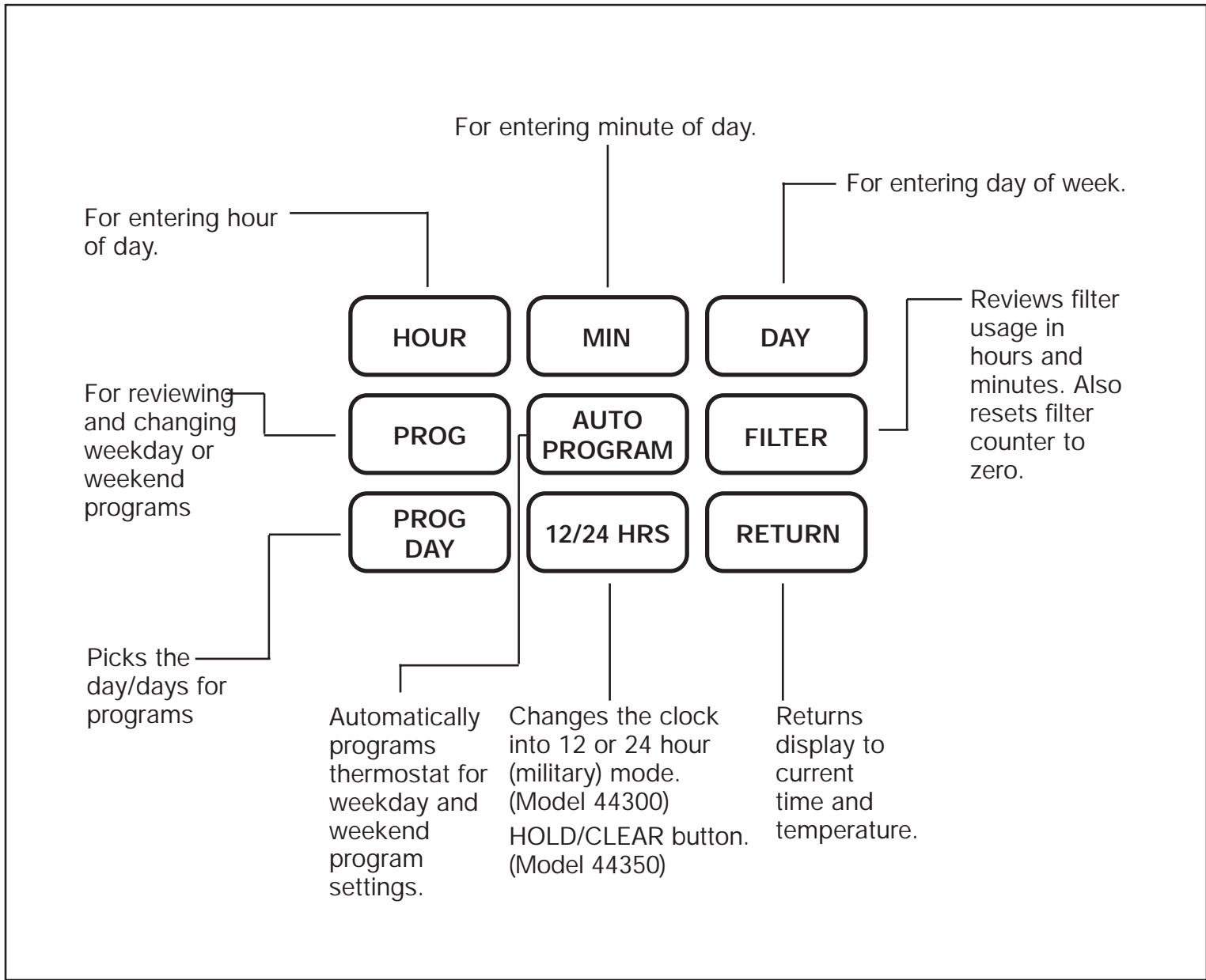

### **What You Need**

This thermostat comes with two #8 slotted screws and two wall anchors for mounting. To install your unit, you should have the following tools and materials.

- Slotted screwdriver
- Electric drill and 3/16" bit
- Hammer
- Two 1.5V (AA) Size Alkaline batteries

### **Remove Old Thermostat**

**CAUTION:** *Do not remove any wiring from existing thermostat before reading the instructions carefully. Wires must be labeled prior to removal.*

- **IMPORTANT!** Turn off the power to the furnace at the main power panel or at the furnace.
- Remove existing thermostat cover and thermostat. See Figure 1. Some thermostats will have screws or other locking devices that must first be removed. Once wall mounting plate is exposed, look for wires.

If wires are not visible, they may be connected to the back of the wallplate. Again, look for screws, tabs, etc. Some models have doors that open to expose wires and mounting screws. (See Figure 1).



TYPICAL HOME THERMOSTATS

FIGURE 1

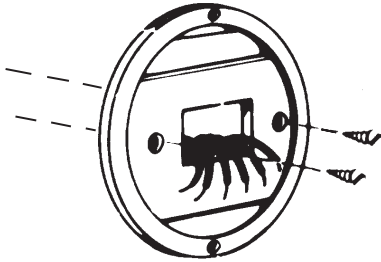

Wall Mounting Plate

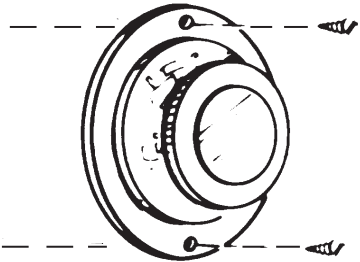

Thermostat

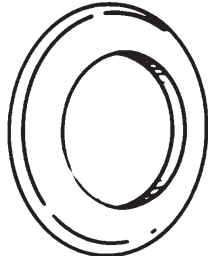

Cover

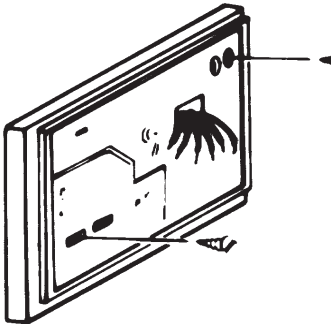

Wall Mounting Plate

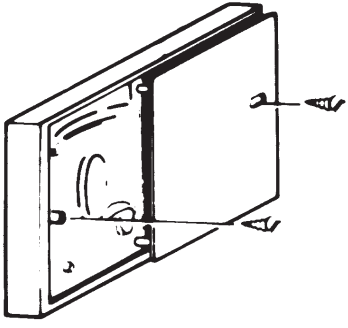

Thermostat

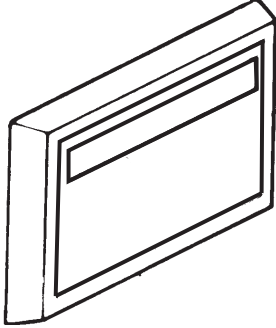

Cover

## Label Wires

- Each wire coming from the wall to the existing thermostat is connected to a terminal point on that thermostat. Each of these terminal points is usually marked with a code letter as shown in Table A on page 11.

The number of wires in your system can be as few as two (for heat only systems), as many as eight, or any number in between. If you follow the labeling procedures correctly, you do not have to be concerned about how many wires there are.

There is often no terminal marking on the existing thermostat of two wire, heat only systems. Do not worry, just connect either of the wires to the RH terminal, then connect the other wire to the W terminal to complete the circuit.

- **IMPORTANT! BEFORE DISCONNECTING ANY WIRES, APPLY THE SELF-ADHESIVE LABELS PROVIDED TO THE WIRE AS SHOWN IN TABLE A ON PAGE 11.** (For example, attach the label marked W to the wire which goes to the W or H terminal on your existing thermostat.) **IGNORE THE COLOR OF THE WIRES** since these do not always comply with the standard.
- After labeling wires, disconnect them from the existing thermostat terminals.
- Remove existing wallplate. To make sure wires do not fall back into wall opening, you may want to tape them to the wall.
- If hole in wall is larger than necessary for wires, seal this hole so that no hot or cold air can enter the back of the thermostat from the wall. This air could cause a false thermostat reading.

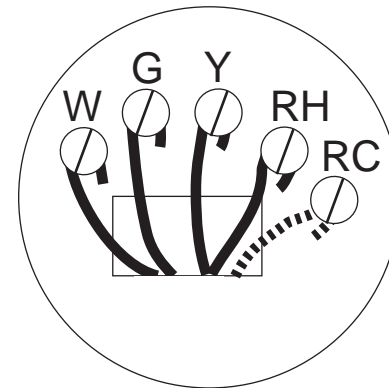

## Wire Labeling

This table will help you match the labels to the wires so you can attach them to your Hunter Thermostat.

**NOTE:** *Follow the labels when connecting wires since many installations do not follow color coding of wires.*











If the code letter on your existing thermostat is	then mark wire with label shown	and connect to thermostat Terminal shown	
RH, R, VR or 4 24 Volt			RED
RC, VC 24 Volt Cool			BLUE
G or F Fan			GREEN
Y, C or M (See Note) Air Conditioning			YELLOW
W or H Heating			WHITE

TABLE A

## Wire Labeling

**NOTE:** *If your thermostat has one wire marked R or RH (4-wire system), then leave the jumper wire between the RH and RC terminals. Otherwise, if you have separate RH and RC wires (5-wire system), then remove the jumper wire between the RH and RC terminals.*

**NOTE:** *Do not connect a "Common" wire (sometimes labelled "C") to any terminal on this thermostat. Tape up the wire and do not use. This wire provides electricity to non-battery powered thermostats.*

## Mount Wallplate and Thermostat

Snap open the wallplate from your thermostat by pressing the release tab on the bottom of the thermostat.

Position wallplate on wall and pull existing wires through large opening. Then level for appearance. Mark holes for plastic anchors provided if existing holes do not line up with Hunter Thermostat holes.

Drill holes with 3/16" bit and gently tap anchors into the holes until flush with wall.

Reposition wallplate to wall, pulling wires through large opening. Insert mounting screws provided into wall anchor and tighten. (See Figure 2.)

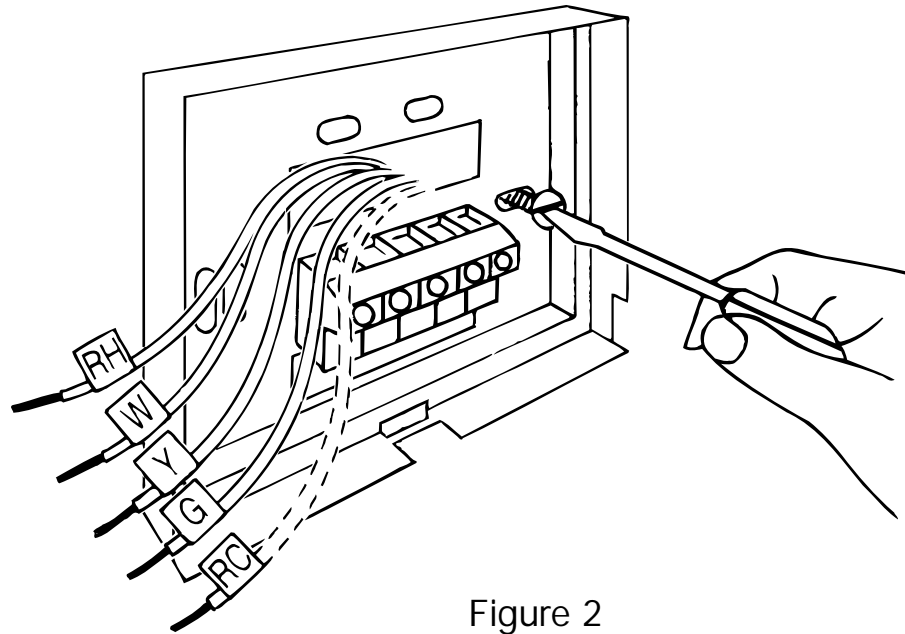

Figure 2

## Selector Switches

The heating system selector and the F°/C° selector switches are located on the Printed Circuit Board.

### ■ Heating system selector

The heating system selector is a switch on the Printed Circuit Board on the inside of the thermostat. The switch is at "HG" position. Leave it in this position if you have a gas furnace or an oil burner.

If you have an electric furnace, test to see whether the heat and fan come on as expected. Leave the switch in the "HG" position. If the fan does not come on when the thermostat calls for heat, change the switch position to "HE."

The system selector has no effect in the cooling mode.

**NOTE:** "HG" position is for gas and most other systems. "HE" position is for certain electric systems having a fan relay.

### ■ F°/C° selector (Fahrenheit/Centigrade)

Your thermostat is set for F° mode from the factory. In order to change to C° mode, slide the switch to C° and press reset button on front of the thermostat with a paper clip. The reset button is located near the display.

**NOTE:** *Unless reset button is pressed, the thermostat will not change the mode.*

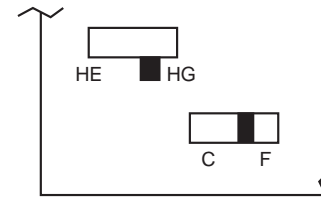

## Connect Wires and Mount Thermostat Cover to Wall Plate

- Match and connect the labeled wires to the appropriate coded terminal screws on the mounting plate. (See Figure 3, 4.) Ignore any wires which may be present, but which were not connected to the old thermostat.

- Be sure to tighten the terminal screws securely, otherwise a loose wire could cause operational problems with your system or thermostat.
- Push excess wire back into hole to prevent interference with mounting of the thermostat cover.
- Make sure the Function Switch is set at OFF, and the FAN-AUTO Switch is in AUTO.
- Insert the bottom tab on the thermostat body into the slot at the bottom of the wallplate. Press top of the thermostat body to snap it into the wallplate. **(NOTE: Do not force the thermostat onto the wallplate, as the terminal pins may be damaged. If it does not snap properly, the thermostat may not work.)**
- Insert the two AA size batteries, observing the polarity marked on the unit.
- Switch on the main power. Press the reset button. (See Figure 5.)
- The LCD display indicates the current room temperature of your house. If it shows random numbers or partial digits, press the reset button once again.
- The installation is now complete. Continue reading Owner's Manual for complete operating instructions.



FIGURE 3

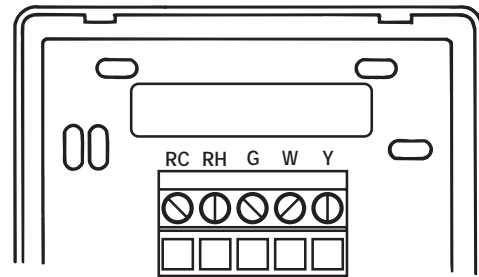

FIGURE 4

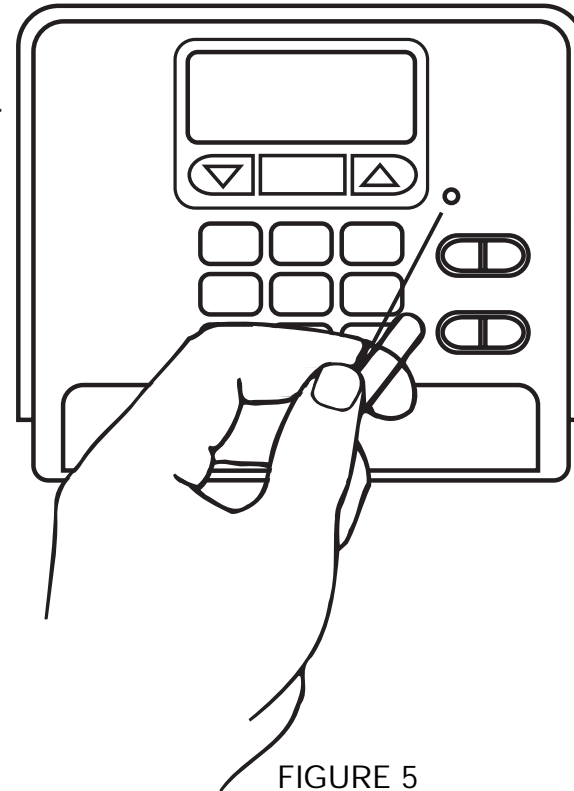

FIGURE 5

- 1 Remove mylar label covering display window.
- 2 When the heating or cooling system is actually operating, "HEAT" or "COOL" will appear on the display.
- 3 If power is interrupted the batteries will keep all programs.
- 4 If "LOW BATT" indicator appears on the display replace the batteries.

## Setting the Time and Day of Week

When you first install the two AA batteries, the thermostat automatically sets the day and time to Monday, 12:00 a.m., shows the current room temperature and is programmed for 68° in heat mode and 78° in cool mode. Press the reset button after installing new batteries.

The first data you should enter is the current time and day of week. As the keys are pressed, the display will show the data being entered.

### EXAMPLE:

If the unit is being installed at 9:15 p.m., Saturday, to set the thermostat, you would press the keys in the shown sequence.

- Initial read-out after pressing reset button.
- Current room temperature is 72°.
- No indication of program number.

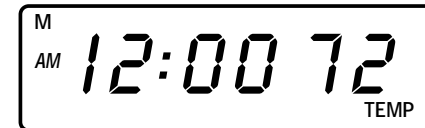

HOUR

- Press once. Temperature digits disappear, show time set mode.

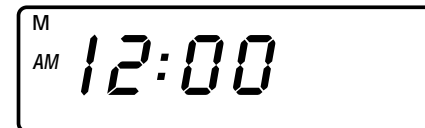



---

**HOUR** ■ Press and hold until current hour appears on display.



M  
PM 9:00

---

**MIN** ■ Press and hold until current minutes appear on display.



M  
PM 9:15

---

**DAY** ■ Press until current day appears on display.



SA  
PM 9:15

---

**RETURN** ■ Returns to normal time and temperature.  
■ If return is not pressed it will return automatically in 10 seconds.



SA  
PM 9:15 72  
TEMP

---

## Typical Suggested Summer and Winter Programs for Maximum Savings

Studies conducted by the Department of Energy estimate that setting your thermostat back 10°F for two 8-hour periods during winter can reduce your fuel bill by as much as 33%. By setting your thermostat up 5° for two 8-hour periods during summer you can reduce your fuel bill up to 25%.

Your thermostat is capable of holding up to 4 separate programs for each day of the week. You can program all weekdays, Monday to Friday, to the same 4 programs as shown in the table, or each weekday can have a different set of 4 programs. Similarly weekend programs, Saturday and Sunday, can be the same 4 programs or each weekend day can have a different set of 4 programs.

A typical set of programs is shown in Table 3.

**MO  
to  
FR**

PROG #	TIME	TEMP IN F° (C°)	
1	5:00AM	68 (20)	78 (25)
2	7:00AM	60 (15)	85 (29)
3	3:00PM	68 (20)	78 (25)
4	10:00PM	62 (16)	82 (27)

**SA  
and  
SUN**

PROG #	TIME	TEMP IN F° (C°)	
1	5:00AM	68 (20)	78 (25)
2	10:00AM	62 (16)	82 (27)
3	3:00PM	68 (20)	78 (25)
4	10:00PM	62 (16)	82 (27)

**TABLE 3**

**NOTE:** *The thermostat program will NOT take effect immediately after programming of your thermostat but at the next programmed time/temperature change. The thermostat is preset to 68°F for heat and 78°F for air conditioning. So if you want a temperature other than 68°F or 78°F right away, use the temporary manual override feature (described on page 28) to enter your desired temperature setting.*

When your program becomes effective at the next time/temperature setting, the appropriate corresponding program number will appear on the display.

**Personal Program Schedule**

Before programming or changing the program, use this Personal Program Schedule to determine which times and temperature settings will best satisfy both your comfort and energy saving requirements.

Use a pencil so you can revise your records each time you change your temperature settings.

**FOR WINTER**

NUMBER	PROGRAM 1	PROGRAM 2	PROGRAM 3	PROGRAM 4
MONDAY	TIME TEMP	TIME TEMP	TIME TEMP	TIME TEMP
TUESDAY	TIME TEMP	TIME TEMP	TIME TEMP	TIME TEMP
WEDNESDAY	TIME TEMP	TIME TEMP	TIME TEMP	TIME TEMP
THURSDAY	TIME TEMP	TIME TEMP	TIME TEMP	TIME TEMP
FRIDAY	TIME TEMP	TIME TEMP	TIME TEMP	TIME TEMP
SATURDAY	TIME TEMP	TIME TEMP	TIME TEMP	TIME TEMP
SUNDAY	TIME TEMP	TIME TEMP	TIME TEMP	TIME TEMP

**FOR SUMMER**

NUMBER	PROGRAM 1	PROGRAM 2	PROGRAM 3	PROGRAM 4
MONDAY	TIME TEMP	TIME TEMP	TIME TEMP	TIME TEMP
TUESDAY	TIME TEMP	TIME TEMP	TIME TEMP	TIME TEMP
WEDNESDAY	TIME TEMP	TIME TEMP	TIME TEMP	TIME TEMP
THURSDAY	TIME TEMP	TIME TEMP	TIME TEMP	TIME TEMP
FRIDAY	TIME TEMP	TIME TEMP	TIME TEMP	TIME TEMP
SATURDAY	TIME TEMP	TIME TEMP	TIME TEMP	TIME TEMP
SUNDAY	TIME TEMP	TIME TEMP	TIME TEMP	TIME TEMP

## Programming Your Thermostat

Your thermostat can be programmed in two different ways.

1. Auto-program method
2. Manual method

Before programming, position the HEAT/OFF/COOL selector to the mode to be programmed.

### Auto-program method

In auto-program method, you can program your thermostat instantly for the entire week by simply pressing "Auto Prog." key once. When this key is pressed, the standard program gets activated and your thermostat is programmed automatically. The standard program is shown in table 4.

If you wish to change this program to suit your life style, you can do so by changing the time and the temperatures of those programs which you want to be different than standard programs. The method is explained in the manual method of programming.

Press  . Your thermostat will be

programmed automatically according to Table 4.

(If the slide switch is in the heat mode, only heat program is effective. In order to activate cool program, slide the switch to cool mode and press "Auto Prog.")

MON. –  
FRI.

SAT. &  
SUN.

PROGRAM NUMBER	TIME	TEMP IN F° (C°)	
		HEAT	COOL
1 2 3 4	5:00AM	68 (20)	78 (25)
	7:00AM	60 (15)	85 (29)
	3:00PM	68 (20)	78 (25)
	10:00PM	62 (16)	82 (27)
1 2 3 4	5:00AM	68 (20)	78 (25)
	10:00PM	60 (15)	85 (29)
	3:00PM	68 (20)	78 (25)
	10:00PM	62 (16)	82 (27)

TABLE 4

### Manual method

In this method, each program is inserted according to your personal programming schedule.

When the battery is first inserted, the thermostat is programmed for 68°F (20°C) in heat mode and 78°F (25°C) in cool mode.







**NOTE: There are no energy saving time or temperature settings.**

Familiarize yourself with manual programming. The following example demonstrates the manual programming method. You can program or change the program of weekdays, weekends, or individual days.

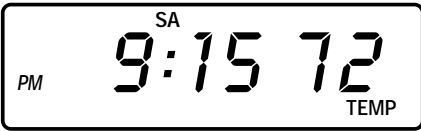
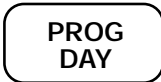
**Programming Your Thermostat (Continued)**

- NOTE: 1) The program time is set in increments of 15 minutes.  
 2) The program temperature is set in increments of 1°F.

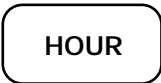
- 3) When setting PM time, make sure the "PM" indicator appears on the display.

	Press	Display Reads	
Weekday Programs			<ul style="list-style-type: none"> <li>Normal display of time, temperature, and day of the week.</li> </ul>
Step 1			<ul style="list-style-type: none"> <li>Selects days M to F for same set of 4 programs each day.</li> </ul>
Step 2			<ul style="list-style-type: none"> <li>Program indicator (1) is displayed.</li> <li>68°F is displayed.</li> <li>0:00 space for time is displayed.</li> <li>M to F is displayed.</li> </ul>
Step 3			<ul style="list-style-type: none"> <li>Press and hold until 6:00 is displayed.</li> <li>Note AM/PM</li> </ul>

**Step 4**

Press **Display Reads**

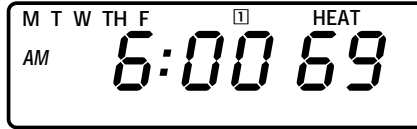
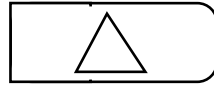

- Press once to change temperature to 69°F.
- Weekday program 1 is complete.
- Press PROG to move to program 2, 3, and 4 and follow the same steps

Use



to insert or change time and temperatures of other programs.

**Continue for Weekend Programs**

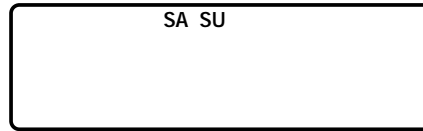

- Selects weekend days SA, SU for same set of 2 programs each weekend day.
- Follow steps 2-4 to enter programs.





Similar to weekday programming.



to insert weekend programs.

### Individual Day Programming

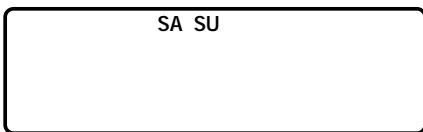
To program for each individual day separately by a different set of programs, first select day by displaying the day of program, then insert the desired times and temperatures.

Press	Display Reads	
		■ M to F are selected. M to F will have same programs.
		■ SA and SU will have same program.
		■ M is selected, program for M only.



Use      to enter programs for Monday.

---

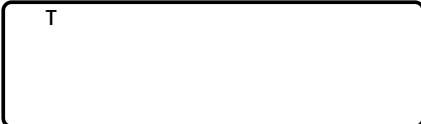



Similarly   ■ T is selected.

---

  ■ W is selected.

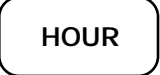
---

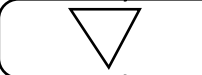
Display the day to be programmed and use

     to enter programs.

---

**NOTE: Another approach to programming is to first program all weekdays M through F and SA and SU as same programs. Then, display and change the programs of only those days which will have different programs.**

**NOTE: If program time remains 0:00, that particular program will not be effective; e.g., if Program #2 has time 0:00, the thermostat will jump from Program #1 to Program #3.**

## Reviewing Programs

You may want to review the programs to see that the settings are compatible with your lifestyle.

### Weekday Program



- Normal display of current time, temperature, and day of week.

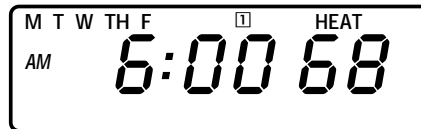

- 1st weekday program is displayed.
- Program indicator (1) appears.
- M to F indication appears.

Continue pressing  to review programs.

**NOTE:** *The temperatures you have entered will NOT take effect immediately, but at the next program time change. The Thermostat is pre-set to 68°F in heat mode and 78°F in cool mode.*

*If you want a temperature other than 68°F or 78°F right away, you must use the manual override feature described below to enter the temperature you want.*

**When your entered program becomes effective, the corresponding program number will appear on the display.**

After programming, confirm the new programs by pressing



PROG

If you are armchair programming the thermostat, before you mount the face of the thermostat, turn the system selector to the OFF position.

## To Review The Current Temperature Setting:

---



■ Current time and temperature

Press  
for 2  
seconds  
or less:

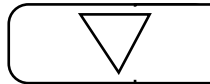

or

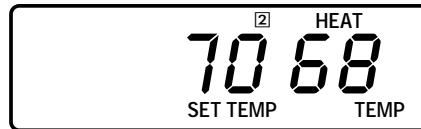
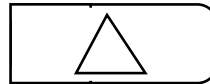

■ 70 indicates the current setting of the thermostat is 70°F. 68 shows the present room temperature as 68°F.

■ If held for more than 2 seconds, you will manually override your present temperature to a new setting as explained below.

## Manual Override of Program

---

### If You Want to Change the Temperature Without Affecting Your Program:

Press and hold  
to raise  
temperature.

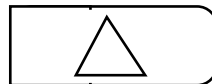

Press and hold  
to lower  
temperature.

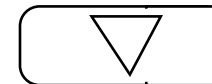

The new temperature will hold until the next program time is reached.

## Temporary Manual Override

In the following example, the present room temperature is 60°F and we want to raise the temperature to 70°F temporarily until the next program.

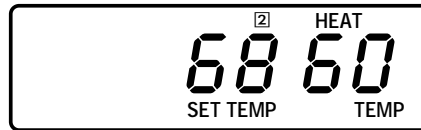
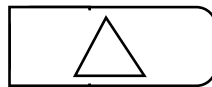

- Press arrow to display current set and room temperatures.

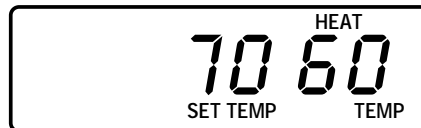
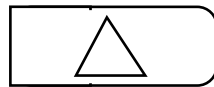

- Continue pressing arrow. After 2 seconds, the set temperature digits will blink and begin to increase until the button is released at the desired setting (in this case 70°F).
- Program number flashes.
- Press return or in 10 seconds it will return to showing current time and temperature.

- To display a manual override setting, press either arrow for less than 2 seconds.
- When arrow is released, the display will show current time and temperature.
- Your thermostat is now in manual override mode to 70°F until the next program. Indicator number flashes until the next program time comes into effect.

## Programming Your Thermostat (Continued)

### Permanent Manual Override

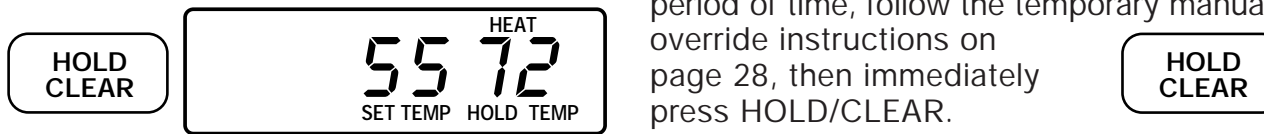

In the event you wish to hold your manual override for vacation or just an extended period of time, follow the temporary manual override instructions on page 28, then immediately press HOLD/CLEAR.

This will maintain override setting indefinitely. "HOLD" will appear on the display.

### To Return To Program\*



(\*From temporary or permanent manual override state)

**NOTE:** *You can also return the current program by pressing "HOLD TEMP" once in permanent override mode.*

■ To return immediately to the current program, press HOLD/CLEAR until program number appears. "HOLD" will disappear if you were in permanent manual override.



## **Temperature Span**

---

Your thermostat is pre-programmed at the factory to cycle when the temperature rises

1° above or 1° below the temperature setting. It cannot be changed.

## **Backlighting (Model 44350 only)**

---

Press

**LIGHT**

Your thermostat comes with an electroluminescent lamp for easy viewing of the display in the dark. To activate press the "light" button between the up and down arrow keys.

The display will remain backlit for approximately five (5) seconds. If another button is pushed, the five second timer will reset, and the light will turn off five seconds after the last button is pressed.

## **12/24 Hour Clock**

---

The 12/24 hour switch is located on the printed circuit board inside the thermostat. (Model 44350 only) Pressing the 12/24 button alternates the clock between 12 or 24 hour (military) mode.

**NOTE: Move system selector slide switch to "OFF" before removing thermostat from wall and changing 12/24 hour clock mode.**

## Operations

72° 71° 70°

### Using the Filter Review Feature

Your thermostat also keeps a record of the number of hours your filter has been in use. To maximize energy efficiency, change or clean your filter regularly.

To help you remember, at 500 hours, the word "FILTER" will appear on the display, reminding you to change the filter and reset

the counter back to zero. The "FILTER" will continue to display if the counter is not set back to zero.

Filter review will display up to 999 hours and 59 minutes of usage. Counter will start from zero after 999 hours and 59 minutes of usage.

**Press for  
2 Seconds  
or Less**

FILTER

FILTER  
1 45 38

- Indicates the usage of filter or total usage in hours and minutes. For example, 145 hours and 38 minutes. (If held for more than 2 seconds, the counter will reset to zero.)

RETURN

SA  
AM 9:15 72  
TEMP

- Back to normal display of time and temperature.
- Auto-return after 10 seconds if no key is pressed.

To reset filter counter back to zero.

**Press and  
Hold for  
3 to 4  
Seconds**

FILTER

FILTER  
1 45 38

- Indicates the usage of filter or total usage in hours.

FILTER  
0 00 00

- The counter will reset to zero.
- When released, returns to current time and temperature.

**NOTE:** Press **FILTER RESET** to clear the filter counter on Model 44300. The counter is only reset when "FILTER" is displayed.

**Problem**

**Solution**

**SCRAMBLED OR DOUBLE DISPLAY**  
(numbers over numbers)

1. Remove clear mylar sticker.

**NO DISPLAY**

1. Check battery connections and batteries.
2. Press reset button once with a small pin and hold in for two seconds.

**ENTIRE DISPLAY DIMS**

1. Replace batteries.

**PROGRAM DOES NOT CHANGE AT YOUR DESIRED SETTING**

1. Check that time is set properly to "AM" or "PM."
2. Check that thermostat is not in "HOLD" mode.
3. Check for correct day setting.

**AUTO/FAN DOES NOT COME ON**

1. Move HG/HE system selector to opposite position.



**HEATING OR COOLING DOES NOT GO ON OR OFF**

1. Check that function switch is in correct position ("HEAT" or "COOL").
2. There may be as much as 20 seconds delay before the system turns on - wait and check.
3. Check your circuit breakers and switches to ensure there is power to the system.
4. Replace batteries.
5. Make sure your furnace blower door is closed properly.
6. If your system only uses 4-wires, be sure the jumper wire is installed between the RC and RH terminals.

---

**ERRATIC DISPLAY**

1. Press the reset button once with a small pin and hold in for two seconds. Then reprogram.

---

**IF UNIT CONTINUES TO OPERATE IN OFF POSITION**

1. Replace unit.

---

**THERMOSTAT READS , HI, LO PERMANENTLY**

1. Replace unit.

---

If you experience any other problems, call 901-745-9222 from 8AM to 5PM Central Standard time for technical assistance.

4-wire Heat/Cool System

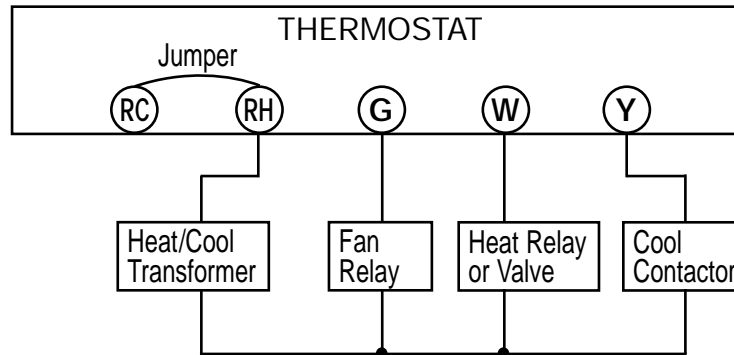

5-wire Heat/Cool System

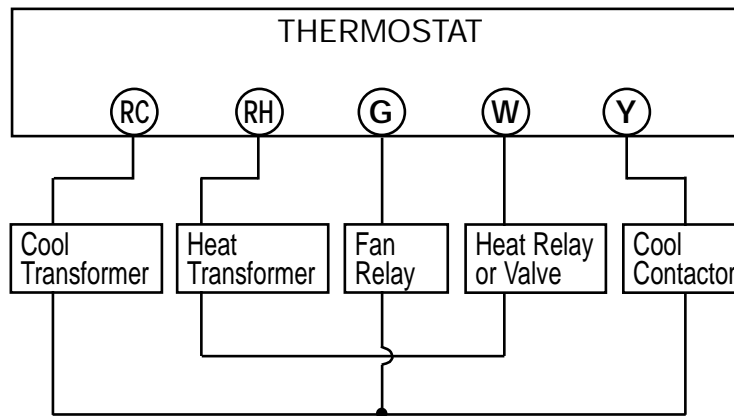

2-wire Heat Only

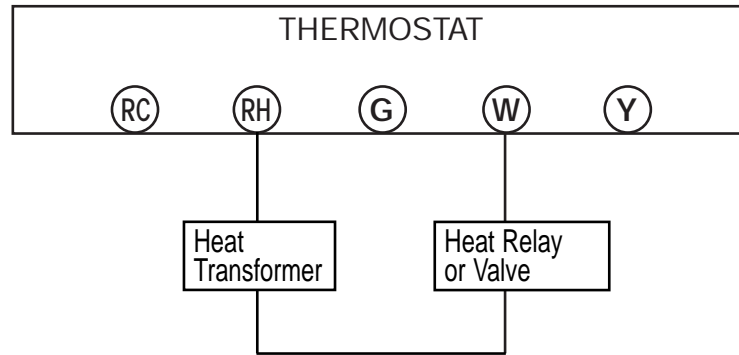

3-wire Heat Only

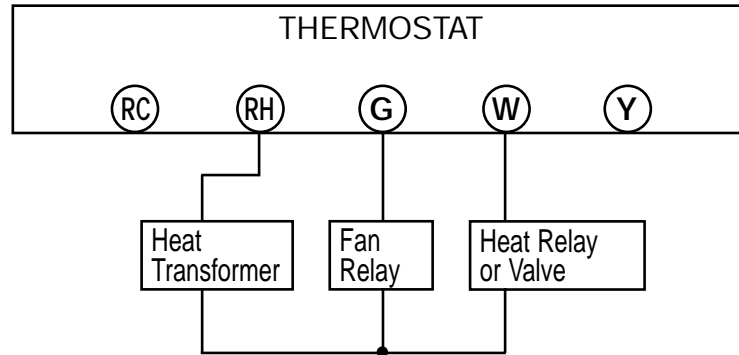

3-wire Cool Only

